

Condizioni operative

Pressione: min 1.0 bar - max 12 bar
 Temperatura: min +4°C - max 70°C
 Portata: min 20 l/min - max 50 l/min

Operating conditions

Pressure: min 1.0 bar - max 12.0 bar
 Temperature: +4° C - 70° C
 Flow rate: from 20 l/min to 50 l/min

Caratteristiche tecniche

Fibra vetro PA 6 30%
 Membrana in parti co-stampata per una miglior tenuta in chiusura
 Astina in acciaio autopulente
 Molla della membrana in acciaio con azione progressiva
 PN12 testato pezzo per pezzo a 14 bar
 Apertura manuale ON/OFF

Technical features

PA 6 30% fiberglass
 Single-piece diaphragm for reliable leak-free valve closing
 Self cleaning stainless-steel metering pin
 Stainless-steel diaphragm differential spring for smooth closing
 PN12 tested piece by piece at 14 bar
 Bleed handle for manual opening with internal bleed

Codice/Code Modelli 24Vac/24Vac Models

100.4500511	E.V. RN 150 FC 24VAC W/FC - 1/2" F
100.4500711	E.V. RN 150 FC 24VAC W/FC - 3/4" F
100.4400711	E.V. RN 150 FC 24VAC W/FC - 3/4" M
100.4500911	E.V. RN 150 FC 24VAC W/FC - 1" F
100.4400911	E.V. RN 150 FC 24VAC W/FC - 1" M
100.4400915	E.V. RN 150 FC 24VAC W/FC - 1" M X UN.

Codice/Code Modelli 9Vdc/9Vdc Models

164.4500711	E.V. RN 150 FC 9VDC (AMP) W/FC - 3/4" F
164.4500911	E.V. RN 150 FC 9VDC (AMP) W/FC - 1" F
164.4400915	E.V. RN 150 FC 9VDC (AMP) W/FC - 1" M X UN.



Via Kennedy 38/40
 20023 - Cerro Maggiore
 Milano - Italy
 www.rain.it



RN 1500

**SOLENOID VALVE
 ELETTROVALVOLA**

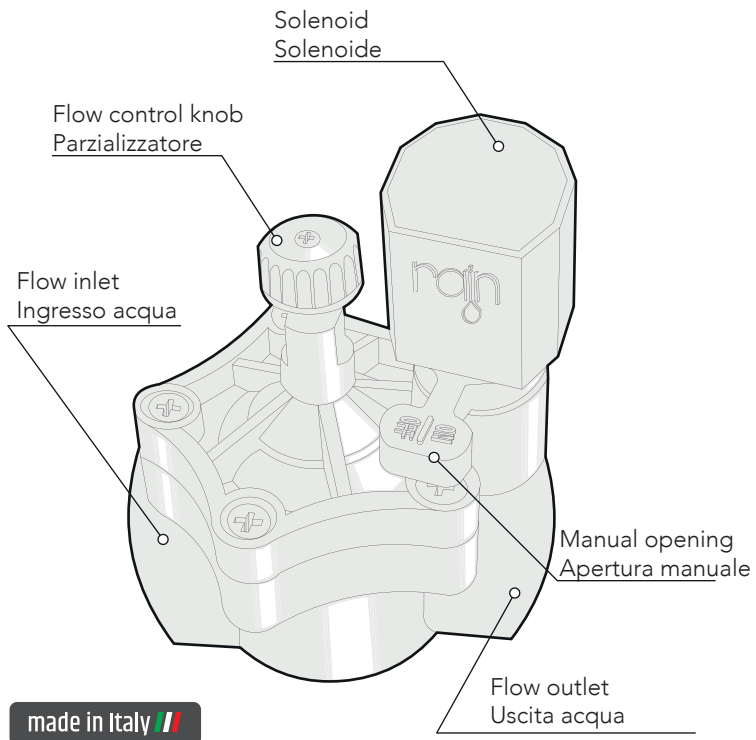

Perdite di carico /Loss of charge (in bar)

Diametro elettrovalvola/Thread model

Portata/Flow	Diametro elettrovalvola/Thread model		
	1/2"	3/4"	1"
20 l/min	0.35	0.35	0.30
30 l/min	0.52	0.52	0.45
40 l/min	0.70	0.60	0.60
50 l/min	0.80	0.80	0.70
60 l/min	0.80	0.80	0.70
70 l/min	0.85	0.85	0.75
80 l/min	0.95	0.95	0.85
90 l/min	1.05	1.05	0.95

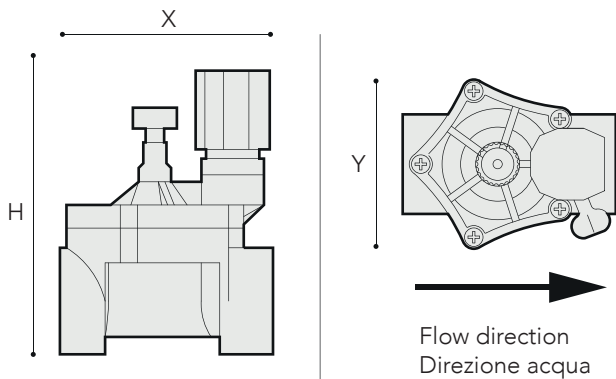

Dimensioni / Dimensions (in cm)

	3/4" M	1" M	1/2" F	3/4" F	1" F	1" MxU	1" UxU
H	11.4	11.4	11.4	11.4	11.4	11.4	11.4
X	11.5	11.6	9.2	9.2	9.2	12.8	14.1
Y	7.1	7.1	7.1	7.1	7.1	7.1	7.1

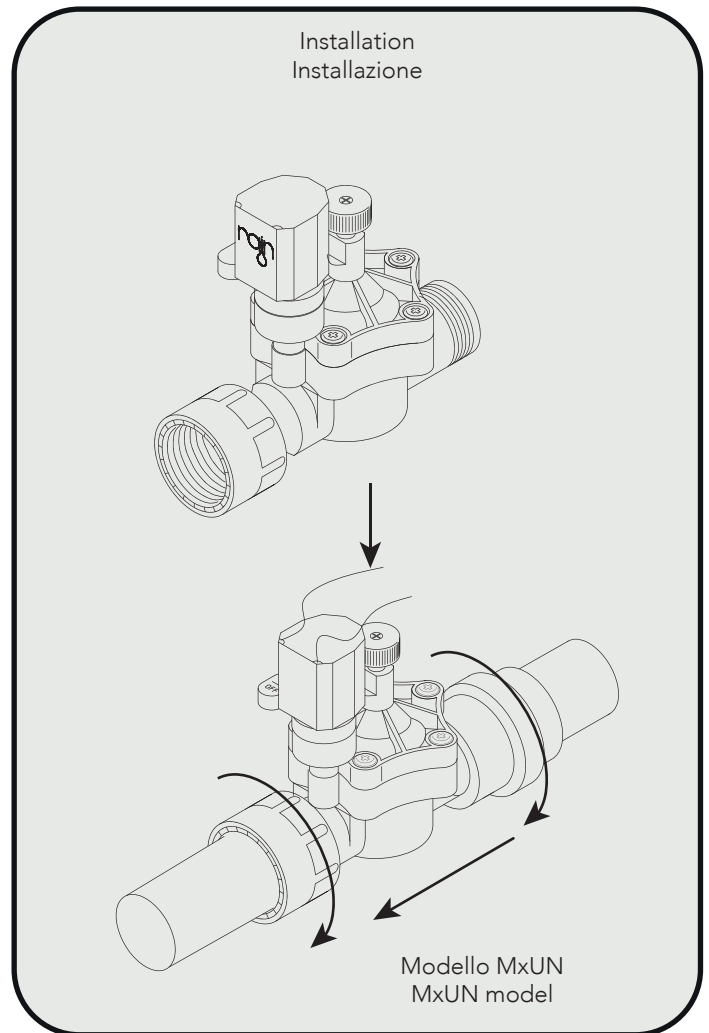

Connection to the 24Vac controller
 Connessioni con il programmatore 24Vac

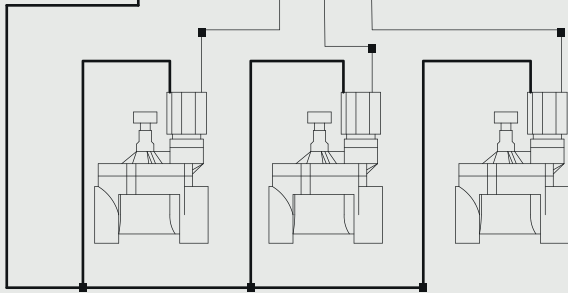
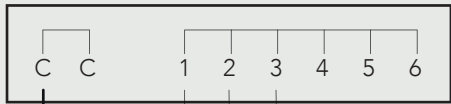
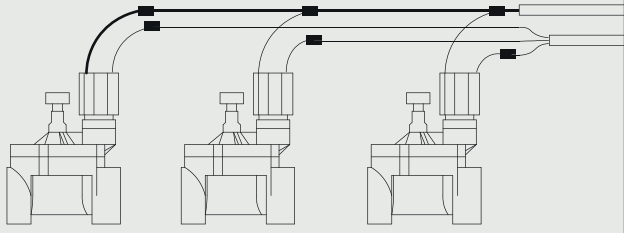

Manual opening
 Apertura manuale

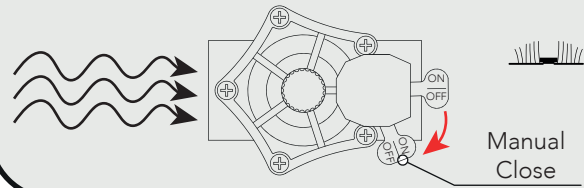
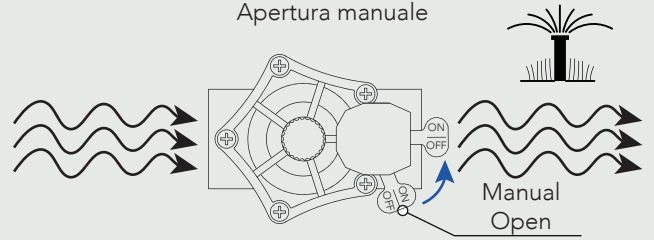

Opening with controller
 Apertura con centralina

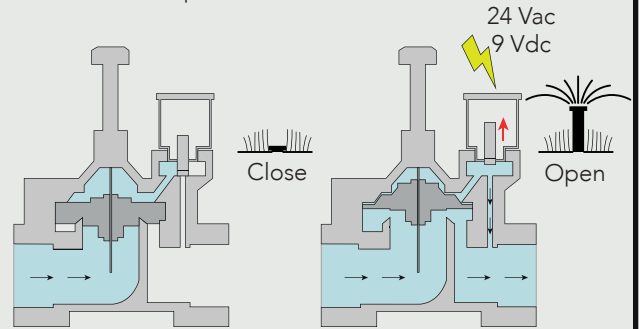

Flow control regulation
 Regolazione parzializzatore

1 Apertura totale/Total opening

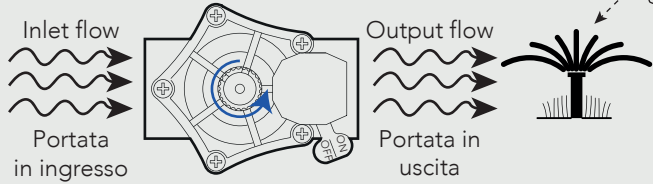

2 Regolazione parzializzatore/Flow control regulation

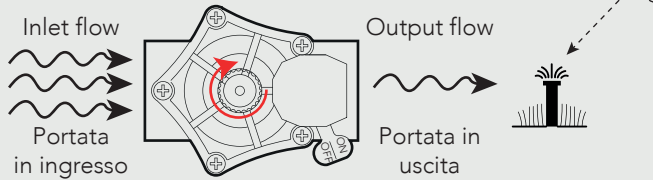

3 Regolazione parzializzatore/Flow control regulation

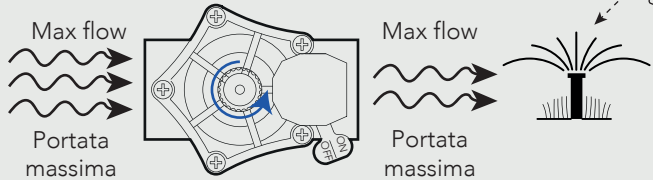

Flow control regulation
 Regolazione parzializzatore

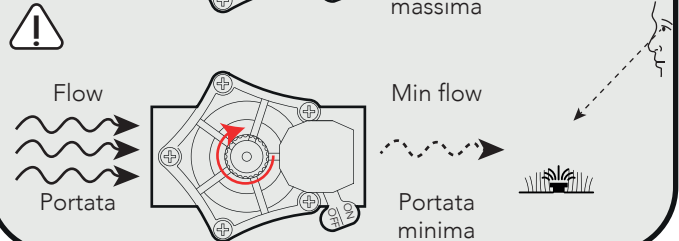
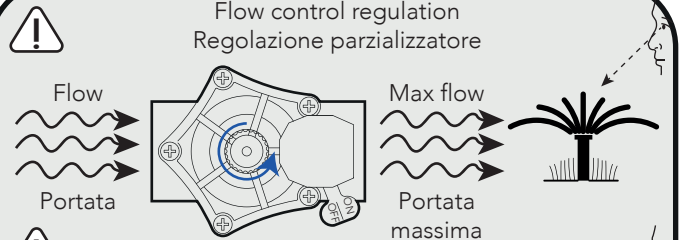

In case of leaking
 In caso di trafileamento

